

Brio ■ Briton ■



Gainsborough

LCN ■



VON DUPRIN



ALLEGION™

PIONEERING SAFETY™



# Commercial Guide

## Introduction

With the ever-increasing technical complexity of building, fire, and disability code compliance, it is more important than ever to specify the appropriate products for security and life-safety.

Allegion creates value by securing people and assets with seamless access wherever they live, learn, work and connect. Let our team of technically trained consultants assist you with product specification and door hardware scheduling to ensure appropriate compliance codes are met.

We have sales offices located in Brisbane, Sydney, Melbourne, Adelaide, and Perth. We would be happy to discuss any project requirements you may have.

## Total solutions

Independently or as an integrated total solution, we can tailor any door hardware schedule to suit your individual security and safety needs for business or home.

**Briton** – Door closers, emergency exit devices, fire door controls, floor springs, pivot sets, transom closers

**Brio** – Screen solutions, tracks and hardware kits for sliding and folding door systems

**Ives and Glynn-Johnson** – Door coordinators, general hardware, pivot sets, overhead stops and holders

**LCN** – Mechanical and electronic door closers, fire door controls

**Legge** – Door furniture, locks and latches, general hardware, hinges

**Schlage** – Electronic access control solutions including general hardware, keying systems, locks and latches, access control readers, and credentials

**Von Duprin** – Emergency exit devices, electronic door control products, electric strikes, exit devices, and power supplies

## Contents

<b>2</b>	<b>Introduction</b>	55	Briton concealed cam action closer
<b>7</b>	<b>Handing and general information</b>	56	Briton door controls
<b>9</b>	<b>Architectural hardware consulting services</b>	57	Briton floor springs
<b>10</b>	<b>Commercial security solutions</b>	58	Briton pivot sets
<b>13</b>	<b>Electronic locks</b>	58	Ives flush bolts
14	Schlage Omnia Fire Rated Smart Lock	59	Ives door coordinators
15	Schlage eGO Smart Hotel Lock	59	Briton door selectors
16	Schlage Breeze accessories	<b>61</b>	<b>Exit devices</b>
17	FSH by Schlage Electric Locks	62	Briton 370 Series
<b>21</b>	<b>Pull handles</b>	63	Von Duprin 22 Series
<b>25</b>	<b>Door furniture</b>	64	Von Duprin 33A
25	Legge 5300 Series	64	Von Duprin 88 Series
28	Legge 5400 Series	65	Von Duprin 99 Series
30	Legge 500Series	65	Von Duprin Exit Device
32	Legge 700 Series	<b>67</b>	<b>Sliding Top Hung Hardware</b>
35	Legge Marine Series	68	Brio Zero Clearance
36	Legge 800 Series	68	Brio Quick Run 120
37	Legge 6000 Series	69	Brio Open Rail
38	Legge 6000 Series Escutcheons	70	Gainsborough Sliding Cavity Set
39	Legge 8000 Series	71	Gainsborough Flush Pulls
40	Schlage 7000 Series	<b>73</b>	<b>General hardware</b>
41	Schlage 7000 Series Escutcheons	74	Door stops
<b>43</b>	<b>Locks</b>	75	Legge pull handles and push plates
44	Legge G2 Series locksets	76	Legge architectural hinges
44	Legge G2 Series deadbolt	76	Schlage door viewer
45	Legge 991MF mortice lock	77	Legge bolts - barrel and chain
45	Legge 990MF mortice locks	77	Floor Ferrules
46	Legge 995MF narrow stile mortice locks	<b>78</b>	<b>Schlage master keying</b>
46	Legge 951 short backset locks		
47	Schlage SR keying		
<b>49</b>	<b>Door controls</b>		
50	LCN 4031, 4031T, 1461, 1461T Series		
51	LCN 4040XP, 4040XPT Series		
53	LCN Door Closers		
54	Briton surface cam action closers		

# RETHINK SPECS

Allegion's Overtur™ is a cloud-based suite of tools that enables architects and door hardware consultants to come together and collaborate on the specifications and security design of doors and openings.

Overtur provides a variety of apps to accomplish such tasks as:



Review designs  
in a real-time  
online environment

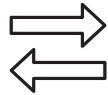

Transfer door data  
– including electrical  
requirements



Upload door data,  
schedule and plans  
directly from BIM



Graphically track  
and review changes

Improved collaboration, coordination and productivity. Overtur is designed to simplify the process of specifying door hardware for your next project.

To learn more, visit [allegion.com.au/overtur](https://allegion.com.au/overtur)



OVERTUR™



ALLEGION™



## Leading the pack

It is imperative for businesses to have contemporary, quality security hardware solutions. At Allegion, we take our leadership in the industry seriously and pride ourselves on continually developing contemporary products to meet the needs of Australians.

To further set us apart in the market, we offer an extensive selection of special finishes to complement architectural designs with a fully automated, leading edge electroplating plant.

With Allegion, you can be assured your door hardware specification combines innovation with style from start to finish.

[www.allegion.com.au](http://www.allegion.com.au)



**Finish glossary** Colours are indicitive only and subject to limitations in the printing process

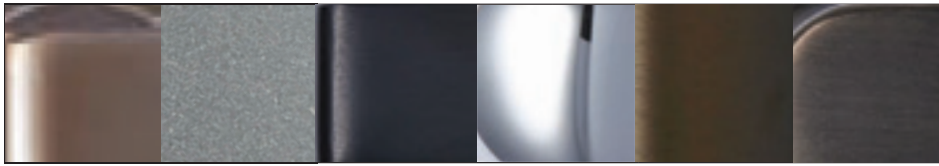

**ABZ** Antique bronze    **ALUM** Aluminium    **BLACK\*** Black    **CP** Chrome    **DKBZ** Dark bronze    **ORB** Oil rubbed bronze



**PB** Polished brass    **SBU** Satin brass unlaquered    **SCP** Satin chrome    **SE\*** Silver    **SNP** Satin nickel    **SSS** Satin stainless steel

\*Contact Allegion or look online for coating type

**Commercial lock functions**

Keyed locks

	<b>Entrance/office lock</b> Push-button locking. Push-button locks outside lever until unlocked with key or by rotating inside lever.
	<b>Entrance lock</b> Turn/push-button locking; pushing and turning button locks outside handle requiring use of key until button is manually unlocked. Push-button locking; pushing button locks outside handle until unlocked by key or by turning inside handle.
	<b>Classroom lock</b> Outside handle locked and unlocked by key. Inside handle always unlocked.
	<b>Storeroom lock</b> Outside handle fixed. Entrance by key only. Inside handle always unlocked.
	<b>Hotel/motel lock</b> Outside handle fixed. Entrance by key only. Push-button in inside handle activates visual occupancy indicator allowing only emergency masterkey to operate. Turning inside handle or closing door releases visual occupancy indicator. Rotation of inside spanner-button provides lockout feature by keeping indicator thrown.

Deadbolt/deadlatch locks

	<b>Single cylinder and turn deadbolt</b> Deadbolt thrown or retracted by key from outside or by inside turn unit. Bolt automatically deadlocks when fully thrown.
	<b>Double cylinder deadbolt</b> Deadbolt thrown or retracted by key from either side. Bolt automatically deadlocks when fully thrown.
	<b>Nightlatch</b> Deadlocking latchbolt retracted by key from outside or by inside turn unit. Rotating turn unit and activating hold-back feature keeps latch retracted.
	<b>Double cylinder deadlatch</b> Deadlocking latchbolt retracted by key from either side. No hold-back feature.

### Door handing guide

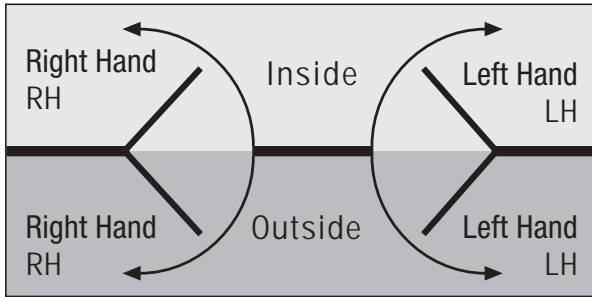

### Hinge handing guide (model 13227)

Right Hand Door		Left Hand Door	
Opening in	Opening out	Opening in	Opening out
Outside	Outside	Outside	Outside

### USA handing guide

When ordering LCN handed closers, use this chart

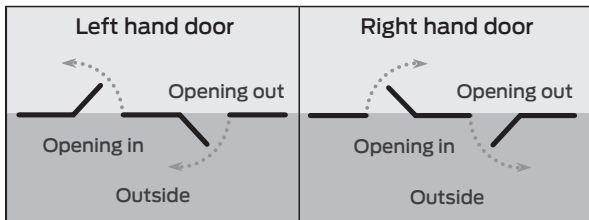

### Common terms

**Door preparation** – A term used for the cut-outs or holes made to the door for the particular lock being installed.

**Backset** – The distance from the edge of the door to the centre line of prep in door.

**Door thickness** – The measurement from outside front through to outside back of door. All locks have a minimum / maximum door thickness which they will fit.

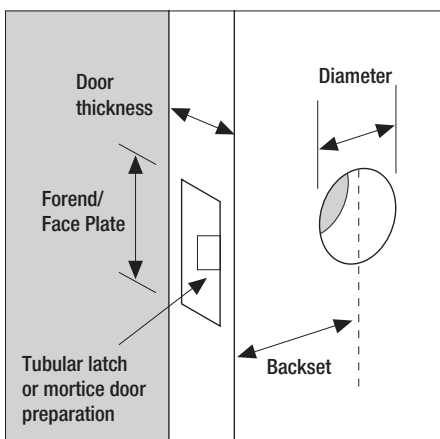

### Services

**Scheduling** – A comprehensive door schedule specification service is provided. Door hardware schedules are available with no obligation.

**Master keying** – Master keying is a method of controlling access through a building. A key schedule is prepared from provided floor plans. Includes a key tracking system which locates keys and locks and keeps a secure procedure on what keying has been undertaken. Security is based on a system where one lock has its own key. This key will not operate any other locks in the system however where all locks are in the same system the locks can be operated by the one master key.

**Keyed alike – KA** – More than one lock being operated by the same key.

**Keyed to differ – KD** – One lock is opened with a single key.

### Lever dimension guide

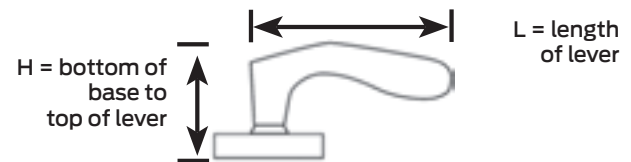

### Product application classification

**Residential and light duty** – Moderate use. Typical applications include residential homes, apartments and low traffic offices.

**Commercial** – Moderate to high traffic flow. Typical applications include classrooms, storerooms, entrance / fire applications.

**Heavy duty** – Excessive high usage / high security subject to abuse. Typical applications include prisons, stairwell doors and air pressure differential.



Fire rated: Tested on fire door assemblies in accordance with Australian Standards, refer fire door manufacturer for specific approval details.



Compliant with AS1428:1-2009 Design for access & mobility standard



Emergency egress



Denotes handed lever / Turn snib



Allegion products are not only designed to complete your architectural vision, but also to suit the operational and security needs of a facility for seamless access.

We offer an extensive range of mechanical and electronic hardware and our experienced team can help you specify the right products to meet all your operational building requirements.

When you partner with Allegion, you receive:

- **Easy collaboration with Overtur**  
Our cloud-based ecosystem allows project team members to collaborate on specifications, design, and construction of door security and openings.
- **Market leading warranties**  
We offer some of the best mechanical warranties in the market.
- **Accurate and detailed specifications**  
Our specification team are experts in their field.
- **Experts across the regions**  
With consultants across the country, you have one point of contact for all your interactions with Allegion.
- **Innovative products**  
Our local engineering and testing capabilities ensure our products are fit for purpose and flexibility of late configuration.

## How we can help

- Hardware specifications
- Door-by-door schedules
- Product elevations
- Substitution request reviews
- Hardware submittals reviews
- Comprehensive product training
- Building, life-safety, and accessibility codes compliance
- Job site reviews and pre and post installation inspections

## Getting started

Contact us and we'll connect you with an Allegion consultant in your area.

To get started, please share with us a copy of the following:

- Architectural floor plans
- Door and frame elevations
- Door schedule/details
- Any known requirements

Allegion serves the access and security needs of various projects, including commercial real estate, aged care facilities, hospitality, apartments, tertiary institutions, schools, government, and healthcare. We understand the practical and regulatory requirements for each market and have an experienced team to assist you in specifying compliant and functional door hardware solutions.



### Aged Care

Aged care facilities have unique requirements that differ across each project and application. Accessibility is a key consideration, including visual disabilities where the colour of the door and the door lever must have visual contrast as per the building code. To enhance user functionality, cam action door closers help users by reducing the force required to open the door. Style is also important for these projects, and our range of special finishes provides options to enhance visual aesthetics of a project.



### Commercial / Retail

Products specified for commercial buildings need to be robust and suitable for heavy use. We can specify both interior and exterior products in marine grade stainless steel. Style is another key consideration and we have a range of durable products available in special finishes to suit your design needs. Security and electronic access options are also available. We understand the accessibility and fire code compliance requirements and can create schedules specifically for your project needs.



### Hospitality

Style is a key consideration in hospitality projects that also have fire and accessibility compliance requirements. Allegion has products to meet both needs with our range of Legge levers with the required accessibility design in 10 different special finishes. Necessary unique access control requirements are met by our digital lock solutions, such as Schlage Omnia.

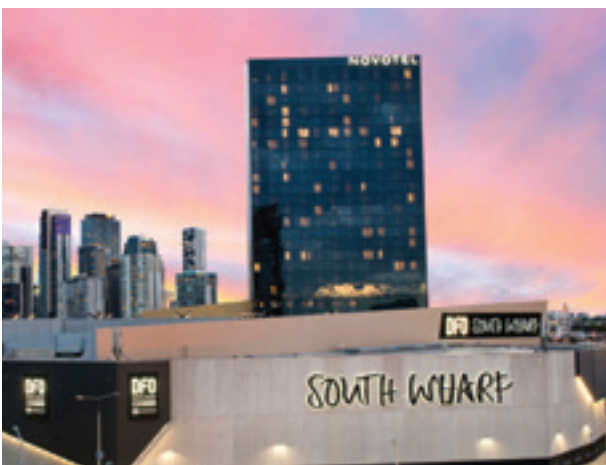



### Apartments

Apartment buildings have requirements that vary depending on the intended customers and use. Some situations may or may not require accessible door hardware, however our team of experts will ensure you get a compliant specification to suit your project. We have a range of electronic entry solutions that will allow you to differentiate your offering to potential buyers. The Schlage Omnia, for example, is a fire rated smart lock perfect for use in apartment buildings. Special finishes are also an opportunity to upgrade your project and provide a unique selling point to customers.



### Education

Primary, secondary, and tertiary institutions have very different access and security requirements. The users of these building types are diverse, varying from small children to adults and those with and without accessibility requirements. For example, master keying is a service we provide for many primary or secondary construction projects, whereas tertiary institutions often require full electronic access solutions. Allegion assists with specification and scheduling to ensure accessibility, fire, and emergency evacuation compliance regulations are met.



### Healthcare

The physical environment of a healthcare facility is the foundation of all that occurs in it. We believe optimising a healthcare facility's physical environment can have a direct link to improved patient health and safety. It also ensures physician and staff safety, security and performance; increasing operational efficiencies and financial outcomes.







# Electronic Locks

## Schlage Omnia Fire Rated Smart Lock



SCEOMMB



SCEOMSNP

● Matte Black    ● Satin Nickel Plate



Fire rated



Compliance



Remote access  
with Schlage Wi-Fi Bridge BZ100



Works with Schlage Breeze™ app



Virtual keys



Built-in alarm



Access with PIN, key tag or  
fingerprint



Key override



Auto re-locking

Technical specifications	Dimensions	Certifications	Warranty
<ul style="list-style-type: none"> <li>- Easily programmable with the Schlage Breeze App</li> <li>- Use voice commands via Google Assistant and Amazon Alexa</li> <li>- Touch screen keypad - up to 150 custom or scheduled pin codes</li> <li>- Fingerprint scanner</li> <li>- 1 year battery life (approximately 10 uses per day)</li> <li>- Refer to page 16 for Schlage Breeze accessories</li> </ul>	<ul style="list-style-type: none"> <li>- External - 313mm (L) x 53mm (W) x 28mm (D)</li> <li>- Internal - 310mm (L) x 53mm (W) x 3mm (D)</li> </ul>	<ul style="list-style-type: none"> <li>- Fire rated: Product has been tested for use in fire doors. Refer to fire door manufacturer for approval.</li> <li>- Accessibility: Compliant to the AS 1428:1-2009 Design for Access and Mobility</li> </ul>	<p>2 year mechanical and electronic</p>

## Schlage eGO Smart Hotel Lock



● Matte Black ● Silver



Fire rated



Programming with Schlage Breeze™ Hotel



Access with PIN, key tag or fingerprint



Mobile access with Schlage Breeze™ Guest



Remote access with Schlage Wi-Fi Bridge BZ100

Technical specifications	Battery	Certifications	Warranty
<ul style="list-style-type: none"> <li>- Operated with the Schlage Breeze Hotel app to manage virtual check-in or remote access</li> <li>- Programmable cards or app-based access for fixed periods of time or days of the week</li> <li>- App integration with existing PMS software via SDK/API</li> <li>- Refer to page 16 for Schlage Breeze accessories</li> </ul>	<p>20,000 cycles (depending on operating conditions)</p>	<ul style="list-style-type: none"> <li>- Fire rated: Product has been tested for use in fire doors. Refer to fire door manufacturer for approval.</li> <li>- Accessibility: Compliant to the AS 1428:1-2009 Design for Access and Mobility</li> </ul>	<p>2 year mechanical and electronic</p>

## Schlage Breeze accessories



Schlage Wi-Fi Bridge  
(BZ100)



Schlage Encoder  
(BZ200)

Technical specifications	Lock Compatibility	Warranty
<ul style="list-style-type: none"> <li>- Network: Wi-Fi 2.4GHz</li> <li>- IEEE standard: 802.11 b/g/n</li> <li>- Power interface: Type-C USB</li> <li>- Power input: 5V/500mA</li> </ul> <p><b>Wi Fi Bridge (BZ100)</b></p> <ul style="list-style-type: none"> <li>- 70mm (L) x 70mm (W) x 20mm (D)</li> </ul> <p><b>Encoder (BZ200)</b></p> <ul style="list-style-type: none"> <li>- 70mm (L) x 70mm (W) x 26mm (D)</li> <li>- Compatible with the Schlage Breeze Hotel system</li> </ul>	<ul style="list-style-type: none"> <li>- Schlage Omnia™ Smart Lock</li> <li>- Schlage eGO Smart Hotel Lock</li> </ul>	<p>1 year electronic</p>



Schlage Keypad Controller  
(BZ300)



Schlage Lift Controller  
(BZ400)

Technical specifications	Lock Compatibility	Warranty
<p><b>Keypad Controller (BZ300)</b></p> <ul style="list-style-type: none"> <li>- 125mm (L) x 79mm (W) x 15mm (D)</li> <li>- Aluminium frame/tempered glass</li> <li>- Bluetooth 4.1</li> <li>- DC12V power supply</li> <li>- 15mA standby current</li> <li>- ≈1A operating current</li> <li>- ≈1.5S unlocking time</li> <li>- Weather resistant IP66</li> <li>- MIFARE M1 S50 card type</li> <li>- App and IC card unlocking</li> </ul> <p><b>Lift Controller (BZ400)</b></p> <ul style="list-style-type: none"> <li>- Bluetooth 4.1</li> <li>- Compatible with iOS7.0 or later / Android 4.3 smartphone or later</li> <li>- 9-16V DC power supply</li> <li>- 10 mA standby current, &lt;400 mA working current</li> <li>- MIFARE M1 S50 card type</li> <li>- App and IC card unlocking</li> </ul>	<ul style="list-style-type: none"> <li>- Schlage Omnia™ Smart Lock</li> <li>- Schlage eGO™ Smart Hotel Lock</li> </ul>	<p>1 year electronic</p>



## FSH by Schlage Electric Strikes



FES7



FES10



FES15



FES20



FES90M-P



FES110



FES112

Product	Function	Holding Strength	Voltage/Current	Approvals	Warranty
FES7	- Power To Open / Power To Lock	Up to 500kg	- 12VDC - 90mA		1 year warranty
FES10 / FES10M	- Power To Lock / Power To Open - Monitored version FES10M	Up to 1000kg	- 12VDC / 24VDC (Dual Voltage) - 200mA / 100mA	Up to 4-hour fire rated* CE/△	5 year warranty
FES15 / FES15M	- Power To Open / Power To Lock - Monitored version FES15M	Up to 1200kg	- 12VDC / 24VDC (Dual Voltage) - 200mA / 100mA	Up to 4-hour fire rated* CE/△	5 year warranty
FES20 / FES20M	- Power To Open / Power To Lock - Monitored version FES20M	Up to 1200kg	- 11-30VDC (Multi-voltage) - 220-80mA	Up to 4-hour fire rated* CE/△ SCEC Approved (SCEC (FES20M)	5 year warranty
FES90M-P	- Power To Open / Power To Lock - Mortice Mount	Up to 1300kg	- 10-30VDC (Multi-voltage) - 300-50mA	Up to 4-hour fire rated* CE/△ SCEC Approved (SCEC Approved Version only)	5 year warranty
FES110	- Power To Open / Power To Lock	Up to 500kg	- 12-30VDC (Multi-voltage) - 900-450mA	Up to 2-hour fire rated*	2 year warranty
FES112	- Power To Open (Fail Secure)	Exceeds 1000kg	- 12-30VDC - 1.5A @ 12VDC / 0.75A @ 24VDC		2 year warranty

\*Contact Allegion for more details

## FSH by Schlage Electric Mortise Lock



FEL990 Series

Product	Function	Voltage/Current	Approvals	Warranty
FEL990	<ul style="list-style-type: none"> <li>- Vestibule and Combination lock</li> <li>- Power To Open / Power To Lock</li> <li>- Field selectable handing</li> </ul>	<ul style="list-style-type: none"> <li>- 12-24VDC (Multi-voltage)</li> <li>- 350mA momentary, 100mA operating</li> <li>- Lock secure status and key override microswitch max. rating 500mA@30VDC</li> <li>- Door status reed switch max. rating 100mA operating</li> </ul>	<p>CE/</p> <p>Up to 4-hour fire rated in accordance with AS1905.1:2015 (contact Allegion for more details)</p>	<ul style="list-style-type: none"> <li>- 10 year warranty (mechanical)</li> <li>- 1 year warranty (electronic)</li> </ul>

## FSH by Schlage Electro Magnetic Locks



**FEM4300 Series**  
Single / Double / Monitored / Non-monitored

● Aluminium ● Black (monitored only)



**FEM6600 Series**  
Single / Double / Monitored / Non-monitored

● Aluminium

Product	Function	Holding Strength	Voltage/Current	Approvals	Warranty
FEM4300	<ul style="list-style-type: none"> <li>- Single door series magnet: 268mm (L) x 48mm (W) x 25mm (D)</li> <li>- Single door series armature plate: 185mm (L) x 38mm (W) x 12mm (D)</li> </ul>	Up to 280kg (for single magnetic lock)	<ul style="list-style-type: none"> <li>- Dual Voltage 12/24VDC</li> <li>- 12VDC = 500mA (Double x2)</li> <li>- 24VDC = 250mA (Double x2)</li> </ul>	Up to 2-hour fire rated* CE/△	5 year warranty
FEM6600	<ul style="list-style-type: none"> <li>- Single door series magnet: 268mm (L) x 73mm (W) x 40mm (D)</li> <li>- Single door series armature plate: 190mm (L) x 61mm (W) x 16mm (D)</li> </ul>	Up to 580kg (for single magnetic lock)	<ul style="list-style-type: none"> <li>- Dual Voltage 12/24VDC 12VDC = 500mA Single (Double x2)</li> <li>- 24VDC = 250mA Single (Double x2)</li> </ul>	Up to 2-hour fire rated* CE/△	5 year warranty

\*Contact Allegion for more details





Pull handles



The Schlage range of pull handles has been designed for residential and commercial applications. This comprises interior and exterior doors for use in retail, educational, institutional, governmental, medical, and public buildings, as well as residential homes.

The range includes both round and square tubular designs. Entrance handles can be fixed to timber, aluminium, and glass doors. They are designed with high quality 316 Marine Grade Stainless Steel to provide greater durability and minimise maintenance.

## Schlage pull handles



**Andor  
S316-1**

Fixing Centres (mm) 300/400/600/800  
Lengths (mm) 325\*/425\*/625/825  
Dimension (mm) 25 x 25



**Capri  
S316-6**

300/450/600/800/1000  
332/482/632/832/1032  
Ø32



**Corfu  
S316-7**

250/400/600/800/1000  
450/600/800/1000/1200  
Ø32



**Dego  
S316-2**

300/450/600/800/1000  
325/475/625/825/1025  
25 x 25



**Silvi  
S316-8**

Fixing Centres (mm) 300/450/600/800  
Lengths (mm) 332/482/632/832/1032  
Dimension (mm) Ø32



**Trento  
S316-4**

600/800/1000  
620/820/1020  
40 x 20



**Turin  
S316-3**

450/600  
600/800  
25 x 25



**Verona\*  
S316-5**

300/450/600/800/1000  
380/530/680/880/1080  
Ø32



Matte Black\*



Satin Stainless Steel

\*Verona available in Satin Stainless Steel only

\* Matte Black available in Andor S316-1 in 325mm or 425mm lengths only

### How to order

Example: Placing an order for Trento pull handle in 820mm length with Satin Stainless Steel finish

Enter  
(prefix code)-(Length)-(Finish)

S316-4-820-SSS

Technical specifications	Door specifications	Warranty
<ul style="list-style-type: none"> <li>- 316 Marine grade stainless steel</li> <li>- Supplied for back-to-back fixing</li> <li>- Other designs and sizes available on indent, price, and lead time for application</li> <li>- Sold in pairs (back to back)</li> </ul>	<p><b>Door type</b></p> <ul style="list-style-type: none"> <li>- Timber, glass, or metal</li> </ul> <p><b>Door thickness</b></p> <ul style="list-style-type: none"> <li>- Timber or aluminium 32mm-70mm</li> <li>- Timber or aluminium 32mm-55mm (Verona)</li> <li>- Glass 10mm-15mm</li> </ul>	<p>10 year mechanical</p>







Door furniture

## Legge 5300 Series



Alpha (29)



Angelo (57)



Bergen (B)



Ergo (62)



Leonardo (12)



Renoir (52)



Rubens (56)

- Antique Bronze
- Chrome
- Oil Rubbed Bronze
- Polished Brass
- Satin Black Chrome
- Satin Brass
- Satin Chrome
- Satin Nickel

Technical specifications	Plate functions	Warranty	Accessories
- 5300 Series <b>Material:</b> - Forged brass - Extruded brass plates <b>Plate dimensions:</b> - L185mm x W25mm x D12mm <b>Door thickness:</b> - 32mm - 55mm - 56mm - 75mm (use extended screws)	- Plain - Oval cylinder hole - Turn snib - Emergency release - Accessible turn	30 year mechanical	- Extended screws <b>Locks/latches:</b> - Legge 995MF mortice lock (990MF mortice lock on request)

# Legge 5300 Series

## External plates

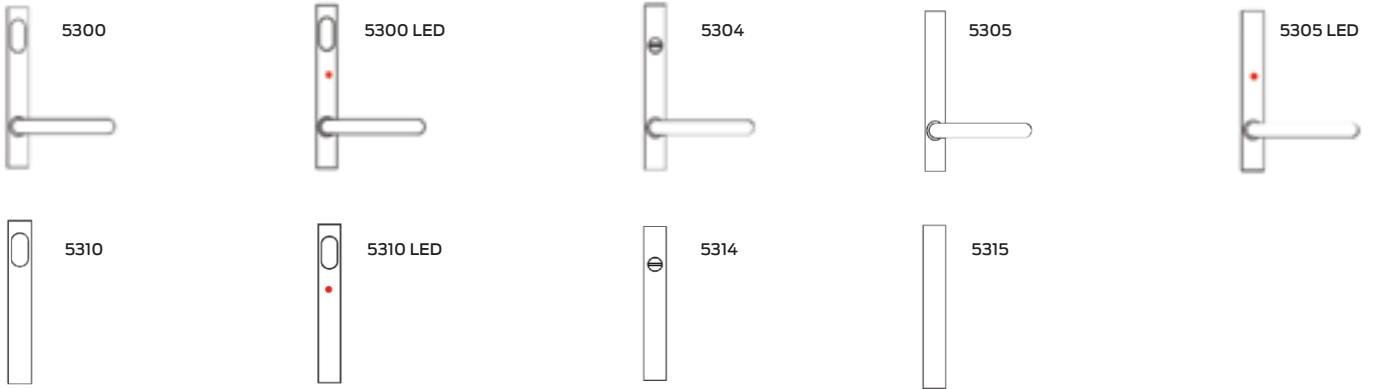

## Internal plates

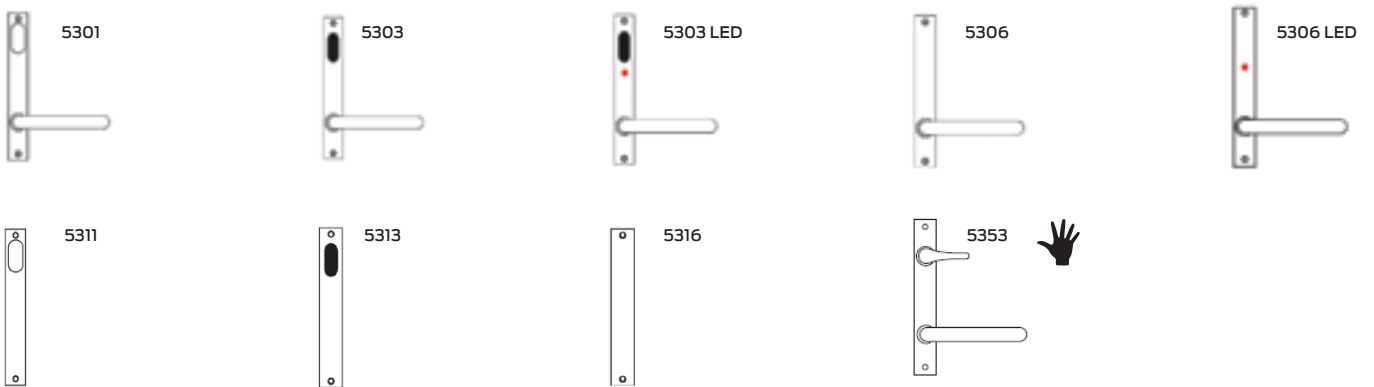

Depicted in RH

### Legend

- Turn snib  LED
- Cylinder hole  Large turn
- Emergency button
- Accessible Turn

## Legge 5400 Series



Alpha (29)



Angelo (57)



Bergen (B)



Ergo (62)



Leonardo (12)



Renoir (52)



Rubens (56)

- Antique Bronze
- Chrome
- Oil Rubbed Bronze
- Polished Brass
- Satin Black Chrome
- Satin Brass
- Satin Chrome
- Satin Nickel

Technical specifications	Plate functions	Warranty	Accessories
- 5400 Series <b>Material:</b> - Forged brass - Extruded brass plates <b>Plate dimensions:</b> - L185mm x W25mm x D12mm <b>Door thickness:</b> - 32mm - 55mm - 56mm - 75mm (use extended screws)	- Plain - Oval cylinder hole - Turn snib - Emergency release - Accessible turn	30 year mechanical	- Extended screws <b>Locks/latches:</b> - Legge 995MF mortice lock

# Legge 5400 Series

## External plates

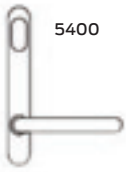

5400

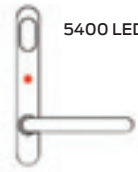

5400 LED

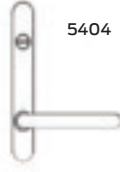

5404

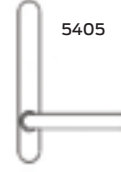

5405

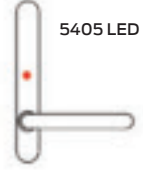

5405 LED



5410



5410 LED



5414



5415

## Internal plates



5401



5403



5403 LED

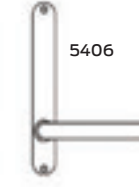

5406



5406 LED



5411



5413



5416

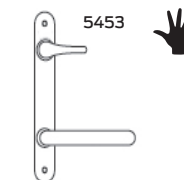

5453

Depicted in RH

### Legend

Turn snib



LED



Cylinder hole



Large turn



Emergency button



Accessible Turn



## Legge 500 Series



Alpha (A)



Angelo (57)



Bergen (B)



Ergo (62)



Leonardo (12)



Rubens (56)

- Antique Bronze
- Chrome
- Oil Rubbed Bronze
- Polished Brass
- Satin Black Chrome
- Satin Brass
- Satin Chrome
- Satin Nickel

Technical specifications	Plate functions	Warranty	Accessories
- 500 Series <b>Material:</b> - Forged brass <b>Plate dimensions:</b> - L168mm x W48mm x D11mm <b>Door thickness:</b> - 32mm - 55mm - 56mm - 75mm (use extended screws)	- Plain - Oval cylinder hole - Turn snib (non-indicating/indicating) - Emergency release (non-indicating/indicating) - Large turn (non-indicating/indicating) - Accessible turn (non-indicating/indicating)	30 year mechanical	- Extended screws <b>Locks/latches:</b> - Legge 990MF mortice lock - Legge 991MF mortice lock - FSH FEL990 electric mortice lock

## Legge 500 Series

### External plates

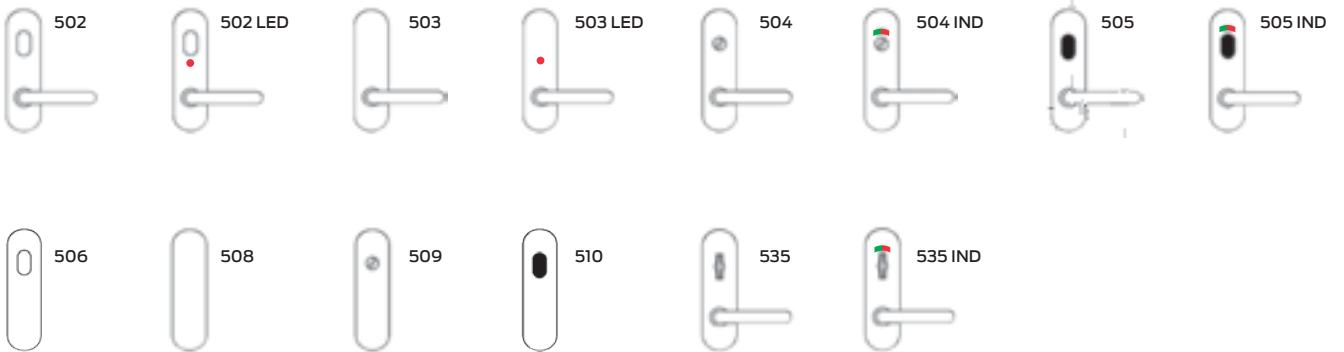

### Internal plates

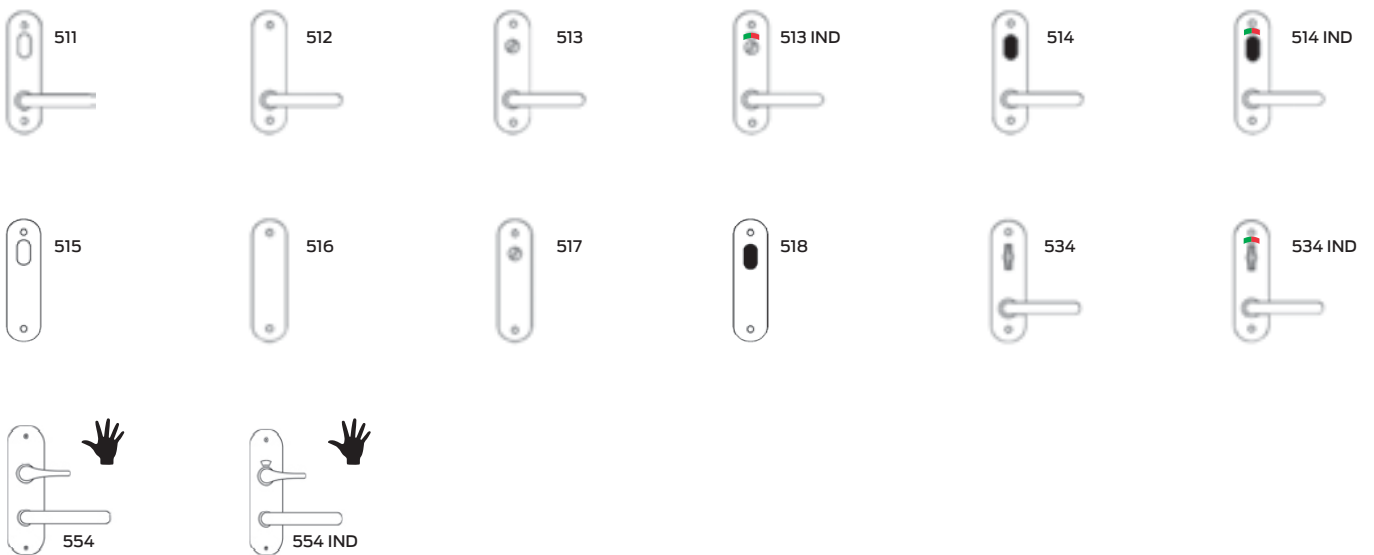

Depicted in RH

Depicted in RH

#### Legend

Turn snib



LED



Cylinder hole



Large turn



Emergency button



Indicating



Accessible turn



Anti-ligature knob



## Legge 700 Series



Alpha (A)



Angelo (57)



Bergen (B)



Ergo (62)



Leonardo (12)



Renoir (52)



Rubens (56)

- Antique Bronze
- Chrome
- Oil Rubbed Bronze
- Polished Brass
- Satin Black Chrome
- Satin Brass
- Satin Chrome
- Satin Nickel

Technical specifications	Plate functions	Warranty	Accessories
- 700 Series <b>Material:</b> - Forged brass <b>Plate dimensions:</b> - L168mm x W48mm x D11mm <b>Door thickness:</b> - 32mm - 55mm - 56mm - 75mm (use extended screws)	- Plain - Oval cylinder hole - Turn snib (non-indicating/indicating) - Emergency release (non-indicating/indicating) - Large turn (non-indicating/indicating) - Accessible turn (non-indicating/indicating)	30 year mechanical	- Extended screws <b>Locks/latches:</b> - Legge 990MF mortice lock - Legge 991MF mortice lock - FSH FEL990 electric mortice lock



# Legge 700 Series

## External plates

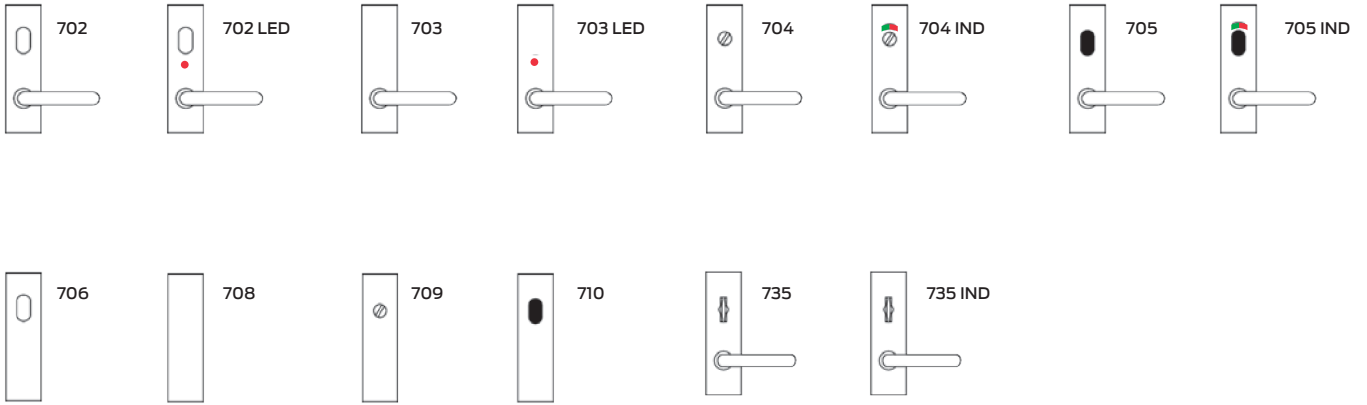

## Internal plates

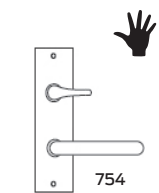
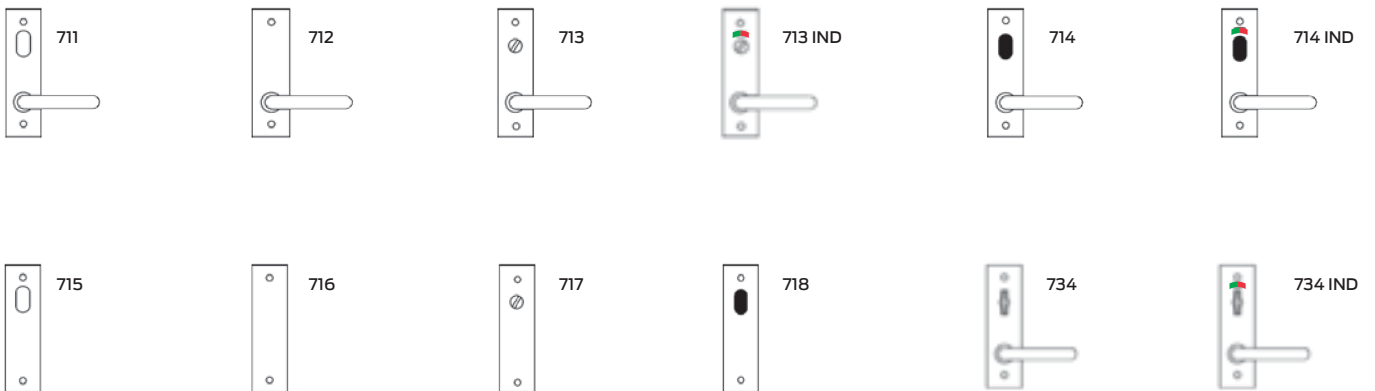

Depicted in RH

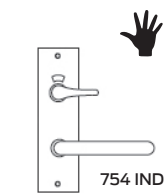

Depicted in RH

### Legend

Turn snib



LED



Cylinder hole



Large turn



Emergency button



Indicating



Accessible turn





## Strength and style

Introducing the Legge Marine Series – an architectural stainless steel range of commercial door furniture.

Constructed from marine grade, 316L stainless steel, the Legge Marine Series offers both strength and style for modern and commercial interiors.

Selected interior and exterior plates from the popular Legge 700 and 5300 Series are available in the Marine Series. Each plate is complete with the popular Alpha lever design – also in 316L stainless steel.

Backed with a 30 year mechanical warranty, the Legge Marine Series will provide durable strength and reliable functionality with style.

A matching entrance handle in 316L stainless steel is also available.

## Legge Marine Series

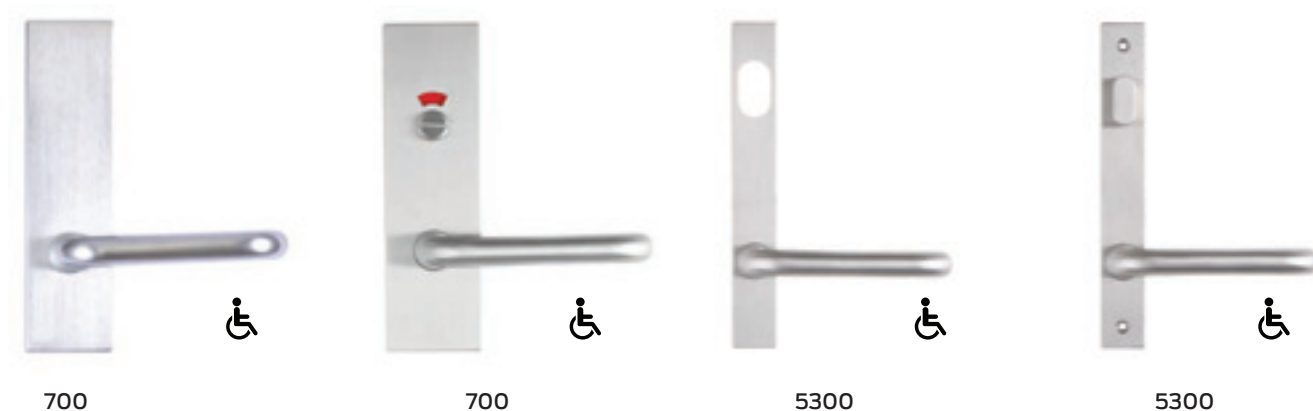

700

700

5300

5300

### 700 Marine Series

Technical specifications	Plate functions	Finishes	Warranty	Accessories
<ul style="list-style-type: none"> <li>- 316L marine grade stainless steel plate &amp; lever</li> <li>- Available with Alpha lever only</li> </ul> <p><b>Material:</b></p> <ul style="list-style-type: none"> <li>- 316L grade stainless steel</li> </ul> <p><b>Plate dimensions:</b></p> <ul style="list-style-type: none"> <li>- L168mm x W45mm x D11mm</li> </ul> <p><b>Door thickness:</b></p> <ul style="list-style-type: none"> <li>- 32mm - 55mm</li> <li>- 56mm - 75mm (use extended screws)</li> </ul>	<ul style="list-style-type: none"> <li>- Oval cylinder hole</li> <li>- Plain plate</li> <li>- Indicating emergency release</li> <li>- Turn snib</li> <li>- Indicating accessible turn</li> </ul>	SSS - Satin stainless steel	30 year mechanical	<ul style="list-style-type: none"> <li>- Extended screws</li> </ul> <p><b>Locks/latches:</b></p> <ul style="list-style-type: none"> <li>- Legge 990MF mortice lock</li> <li>- Legge 991MF mortice lock</li> <li>- FSH FEL990 electric mortice lock</li> </ul>

### 5300 Marine Series

Technical specifications	Plate functions	Finishes	Warranty	Accessories
<ul style="list-style-type: none"> <li>- 316L marine grade stainless steel plate &amp; lever</li> <li>- Available with Alpha lever only</li> <li>- Suitable for narrow stile joinery</li> </ul> <p><b>Material:</b></p> <ul style="list-style-type: none"> <li>- 316L grade stainless steel</li> </ul> <p><b>Plate dimensions:</b></p> <ul style="list-style-type: none"> <li>- L185mm x W25mm x D13mm</li> </ul> <p><b>Door thickness:</b></p> <ul style="list-style-type: none"> <li>- 32mm - 55mm</li> <li>- 56mm - 75mm (use extended screws)</li> </ul>	<ul style="list-style-type: none"> <li>- Oval cylinder hole</li> <li>- Plain plate</li> <li>- Emergency release</li> <li>- Turn snib</li> <li>- Accessible turn</li> </ul>	SSS - Satin stainless steel	30 year mechanical	<ul style="list-style-type: none"> <li>- Extended screws</li> </ul> <p><b>Locks/latches:</b></p> <ul style="list-style-type: none"> <li>- Legge 995MF mortice lock</li> </ul>

## Legge 800 Series



Alpha (A)



Bergen (B)

● Satin Chrome Plate

Please contact Allegion if you require an AS 1428.1-2021 accessibility compliant solution

Technical specifications	Warranty	Accessories
<p><b>Plate dimensions</b> - 128mm (L) x 128mm (W) x 64mm (D)</p> <p><b>Material</b> - Forged brass levers and plates</p> <p><b>Fixing</b> - Back to back - Concealed fixing on external plates</p> <p><b>Door thickness</b> - 32mm - 50mm</p>	<p>30 year mechanical</p>	<p><b>Locks/latches</b> - Legge 991MF and 990MF mortice lock</p> <p><b>Other</b> - Extended screws</p>

### External plates and pulls for left hand doors

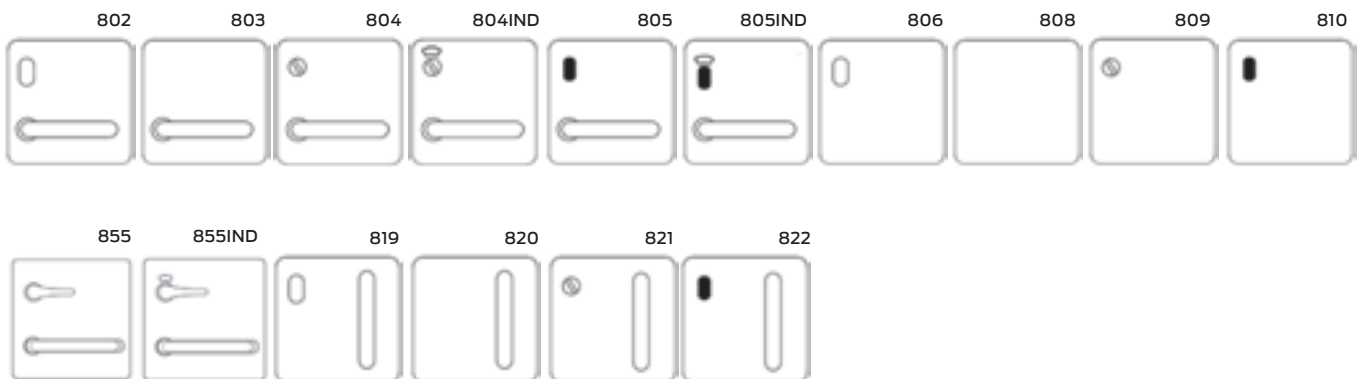

### Internal plates and pulls for left hand doors

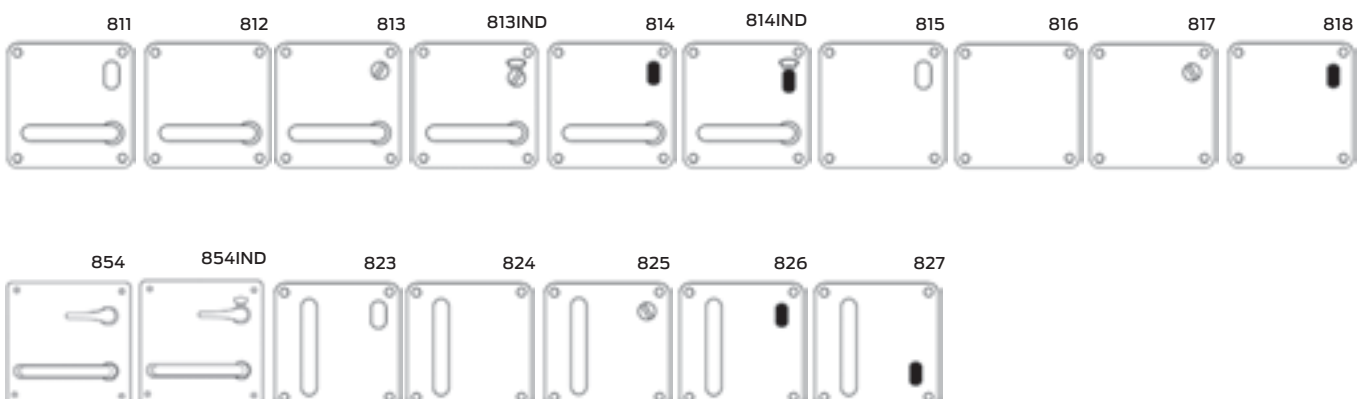

## Legge 6000 Series



Alpha (29)



Angelo (57)



Bergen (B)



Ergo (62)



Leonardo (12)



Renoir (52)



Rubens (56)

- Antique Bronze
- Chrome
- Oil Rubbed Bronze
- Polished Brass
- Satin Black Chrome
- Satin Brass
- Satin Chrome
- Satin Nickel

Technical specifications	Functions	Warranty	Accessories
<p><b>Rose specifications:</b></p> <ul style="list-style-type: none"> <li>- Ø55mm x D12mm</li> <li>- Concealed fixing</li> </ul> <p><b>Material:</b></p> <ul style="list-style-type: none"> <li>- Forged brass levers</li> <li>- Die cast roses</li> </ul> <p><b>Backset:</b></p> <ul style="list-style-type: none"> <li>- 60mm standard on passage and privacy latch</li> <li>- Suitable to use latch furniture with mortice locks and escutcheons</li> </ul> <p><b>Door thickness:</b></p> <ul style="list-style-type: none"> <li>- Passage and furniture 32mm - 55mm</li> <li>- Privacy 32mm - 42mm</li> </ul>	<ul style="list-style-type: none"> <li>- 6000 - Latch furniture</li> <li>- 6001 - Half set</li> <li>- 6002 - Dummy</li> <li>- 6003 - Blank rose</li> <li>- 6005 - Passage</li> <li>- 6006 - Privacy</li> </ul>	<p>10 year mechanical</p>	<p>- Extended screws</p> <p><b>Locks/latches:</b></p> <ul style="list-style-type: none"> <li>- Schlage 60mm latchbolt*</li> <li>- Legge 990MF mortice lock</li> <li>- Legge 991 mortice lock</li> <li>- FSH FEL990 electric mortice lock</li> </ul> <p><b>Escutcheons:</b></p> <ul style="list-style-type: none"> <li>- Legge 6000 Series escutcheons</li> </ul>

\*Light duty applications only



6000 - Lock/latch furniture



6001 - Half set



6002 - Half set fixed



6003 - Blank rose



6005 - Passage latchset (60mm backset)



6006 - Privacy latchset (60mm backset)

## Legge 6000 Series Escutcheons



Oval cylinder hole  
#6008



Euro profile cylinder hole  
#6012



Emergency release  
#6009



Indicating emergency release  
#6014



Turn  
#6007



Oval cylinder hole  
#6008



Accessible turn LH/RH  
#6054



Accessible indicating turn  
LH/RH  
#6054IND

- Antique Bronze
- Chrome Plate
- Oil Rubbed Bronze
- Polished Brass
- Satin Black Chrome
- Satin Brass
- Satin Chrome Plate
- Satin Nickel

### Technical specifications

- Ø50mm x D9mm
- Concealed fixing
- Brass

### Warranty

10 year mechanical

## Legge 8000 Series



Alpha (29)



Angelo (57)



Bergen (B)



Ergo (62)



Leonardo (12)



Renoir (52)



Rubens (56)

- Chrome
- Satin Black Chrome
- Satin Chrome
- Satin Nickel

Technical specifications	Functions	Warranty	Accessories
<p><b>Rose specifications:</b></p> <ul style="list-style-type: none"> <li>- W57mm x L57mm x D12mm</li> <li>- Concealed fixing</li> </ul> <p><b>Material:</b></p> <ul style="list-style-type: none"> <li>- Forged brass levers</li> <li>- Die Cast Roses</li> </ul> <p><b>Backset:</b></p> <ul style="list-style-type: none"> <li>- 60mm standard on passage and privacy latch</li> <li>- Suitable to use latch furniture with mortice locks and escutcheons</li> </ul> <p><b>Door thickness:</b></p> <ul style="list-style-type: none"> <li>- Passage and furniture 32mm - 55mm</li> <li>- Privacy 32mm - 42mm</li> </ul>	<ul style="list-style-type: none"> <li>- 8000 - Latch furniture</li> <li>- 8001 - Half set</li> <li>- 8002 - Dummy</li> <li>- 8003 - Blank rose</li> <li>- 8005 - Passage</li> <li>- 8006 - Privacy</li> </ul>	<p>10 year mechanical</p>	<ul style="list-style-type: none"> <li>- Extended screws</li> </ul> <p><b>Locks/latches:</b></p> <ul style="list-style-type: none"> <li>- Schlage 60mm latchbolt*</li> <li>- Legge 990MF mortice lock</li> <li>- Legge 991MF mortice lock</li> <li>- FSH FEL990 electric mortice lock</li> </ul> <p><b>Escutcheons:</b></p> <ul style="list-style-type: none"> <li>- Legge 8000 Series escutcheons</li> </ul>

\*Light duty applications only



8000 - Lock/latch furniture

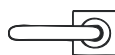

8001 - Half set



8002 - Half set fixed



8003 - Blank rose



8005 - Passage latchset  
(60mm backset)



8006 - Privacy latchset  
(60mm backset)

## Schlage 7000 Series



Albo (713)



Alpha (715)



Angelo (714)



Costa (717)



Stefano (722)



Telo (716)

● Satin Stainless Steel

Technical specifications	Plate functions	Warranty	Accessories
- Timber or metal Spindle size: <b>Spindle size:</b> - 7.6mm <b>Material:</b> - Solid or tubular stainless steel handles, die cast roses <b>Backset:</b> - 60mm or 70mm <b>Door thickness:</b> - Latch furniture 35mm to 50mm - Passage set 35mm to 50mm - Privacy set 32mm to 42mm	- 7002 - Dummy trim - 7000 - Latch furniture - 7005 - Passage set (60mm or 70mm backset) - 7006 - Privacy set (60mm or 70mm backset)	10 year mechanical	- Tubular latches - ME series mortice locks - FSH FEL990 Series mortice lock - Legge 990MF mortice lock - Legge 991MF mortice lock



7000 - Lock/latch furniture



7002 - Dummy trim

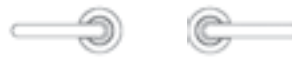

7005 - Passage set  
(60mm or 70mm backset)

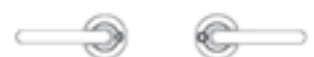

7006 - Privacy latchset  
(60mm or 70mm backset)



## Schlage 7000 Series Escutcheons



Turn  
#7007



Cylinder  
#7008



Emergency release  
#7009



Accessible Turn  
#7054



Euro profile cylinder  
#7012



Indicating turn  
#7013



Indicating emergency release  
#7014



Indicating accessible turn  
#7054IND

● Satin Stainless Steel

### Technical specifications

- Ø50mm x D9mm
- Concealed fixing
- Brass

### Warranty

10 year mechanical

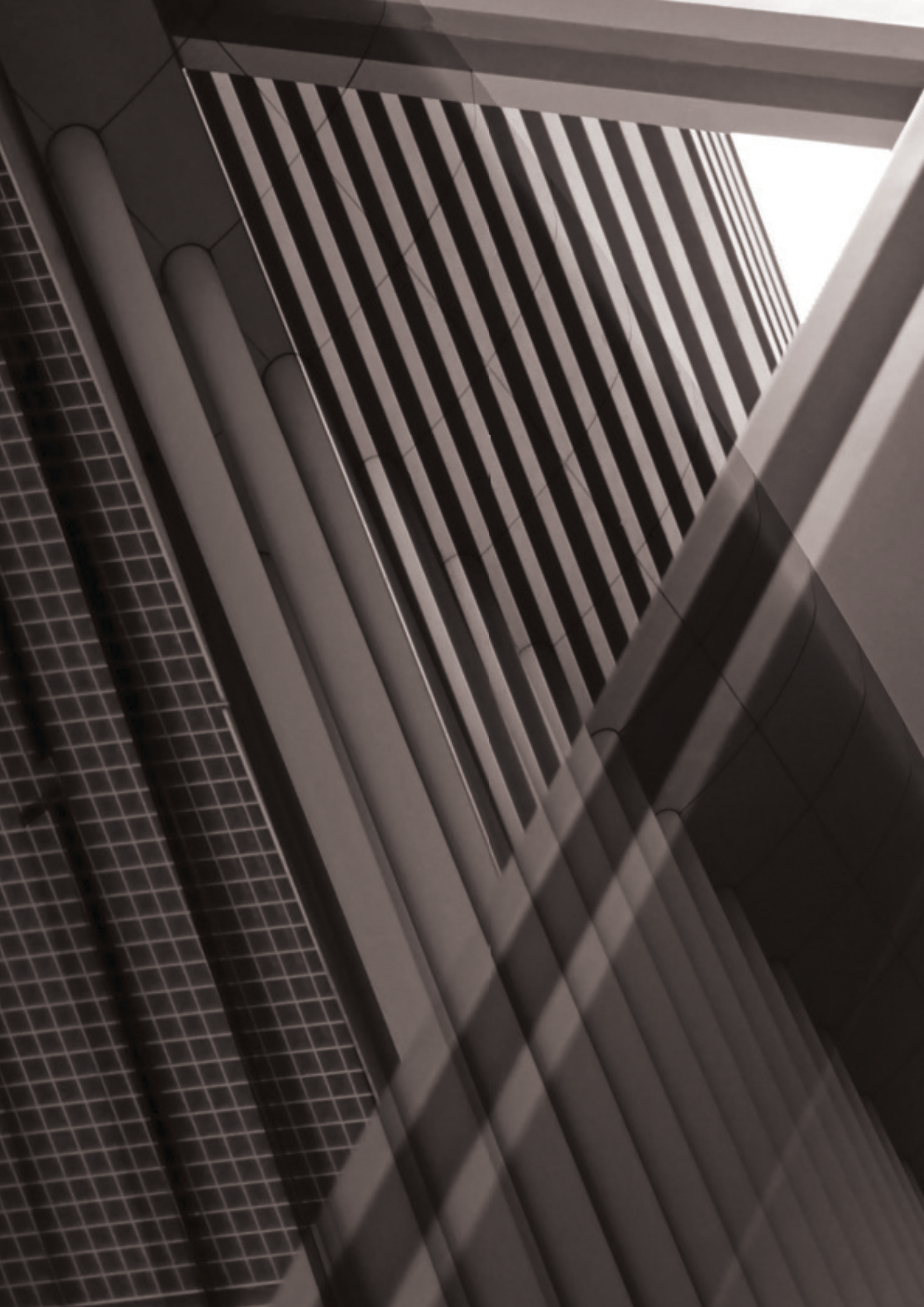



# Locks

## Legge G2 Series locksets



Orbit



Sparta



Fire rated



Accessible

● Matte Black ● Satin Chrome Plate

Technical specifications	Functions	Finishes	Warranty
<ul style="list-style-type: none"> <li>- ANSI grade 2 performance</li> <li>- Vandgard® Option</li> </ul> <p><b>Rose specifications:</b></p> <ul style="list-style-type: none"> <li>- Orbit - 70mm</li> <li>- Sparta - 75mm</li> <li>- Concealed fixing</li> </ul> <p><b>Backset:</b></p> <ul style="list-style-type: none"> <li>- 70mm standard</li> <li>- 60mm and 127mm available</li> <li>- Concealed fixing on external plates</li> </ul> <p><b>Door thickness:</b></p> <ul style="list-style-type: none"> <li>- 32mm - 50mm</li> <li>- 45mm - 60mm available (Sparta)</li> </ul> <p><b>Keyway:</b></p> <ul style="list-style-type: none"> <li>- Schlage C4 6-pin keyway profile</li> </ul>	<p><b>Orbit</b></p> <ul style="list-style-type: none"> <li>- Entrance handle (ENT)</li> <li>- Escape handle (ESC)*</li> </ul> <p><b>Sparta</b></p> <ul style="list-style-type: none"> <li>- Entrance lock (ENT)</li> <li>- Passage latch (PAS)</li> <li>- Privacy latch (PRI)</li> <li>- Classroom latch (CLA)</li> <li>- Storeroom lock (STR)</li> <li>- Dummy trim (DUM)</li> <li>- Vanguard entrance (VENT)</li> </ul>	<p><b>Orbit</b></p> <ul style="list-style-type: none"> <li>- Satin Stainless Steel</li> </ul> <p><b>Sparta</b></p> <ul style="list-style-type: none"> <li>- Satin Chrome Plate</li> <li>- Black</li> </ul>	<p>10 year mechanical and finish</p>

\* Orbit Escape handle (ESC) only available in Satin Chrome Plate finish.

## Legge G2 Series deadbolt



(Single cylinder shown)

● Matte Black ● Satin Chrome Plate

Technical specifications	Functions	Finishes	Warranty
<ul style="list-style-type: none"> <li>- ANSI/BHMA grade 2 performance</li> </ul> <p><b>Rose specifications:</b></p> <ul style="list-style-type: none"> <li>- Ø65mm</li> </ul> <p><b>Backset:</b></p> <ul style="list-style-type: none"> <li>- 60mm or 70mm adjustable</li> </ul> <p><b>Door thickness:</b></p> <ul style="list-style-type: none"> <li>- 32mm - 50mm</li> </ul> <p><b>Keyway:</b></p> <ul style="list-style-type: none"> <li>- Schlage C4 6-pin keyway standard</li> <li>- Schlage SRW keyway optional</li> </ul>	<ul style="list-style-type: none"> <li>- Single cylinder deadbolt (G2BOLTSC)</li> <li>- Double cylinder deadbolt (G2BOLTDC)</li> </ul>	<ul style="list-style-type: none"> <li>- Satin Chrome Plate</li> </ul>	<p>10 year mechanical and finish</p>

## Legge 991MF mortice lock



- Antique Bronze
- Oil Rubbed Bronze
- Polished Brass
- Satin Brass
- Satin Black Chrome
- Satin Chrome Plate
- Satin Stainless Steel
- Satin Nickel

Technical specifications	Functions	Warranty	Accessories
<b>Backset:</b> - 60mm <b>Door thickness:</b> - 32mm - 50mm <b>Door type:</b> - Metal - Timber	- Entry lock - Glass door lock - Turn entry lock - Double cylinder lock - Privacy latch - Passage latch - Vestibule lock - Exterior and exit lock - Storeroom lock - Single Action lock - Anti-lockout lock - Exit latch	30 year mechanical	- Single cylinder and turn - Double cylinder - Slam shut strike plate

## Legge 990MF mortice locks



Deadlock  
(D Series)



Nightlatch  
(N Series)



Sliding door  
(S Series)

- Antique Bronze
- Oil Rubbed Bronze
- Polished Brass
- Satin Brass
- Satin Black Chrome
- Satin Chrome Plate
- Satin Stainless Steel
- Satin Nickel

Technical specifications	Functions	Warranty	Accessories
<b>Backset:</b> - 60mm standard - 70, 89, 127mm also available <b>Door thickness</b> - 32mm - 50mm standard <b>Door type</b> - Timber - Metal <b>Materials</b> - Stainless steel inner and outer - Forend and strike supplied as standard	- C - Combination - D - Deadlocking - N - Nightlatch - S - Sliding doors - V - Vestibule	30 year mechanical	- Rebate kit (C, D, N, and V series) - Long and short lipped strikes (V and C series) <b>Cylinder:</b> - Oval cylinder <b>Furniture:</b> - Legge 5300 & 5400 Series - Legge 6000 & 8000 Series M version - Legge 500 & 700 Series - Legge 800 Series

## Legge 995MF narrow stile mortice locks



995MF mortice lock

995MF mortice lock  
Timber forend

Combination / Vestibule

- Antique Bronze
- Chrome Plate
- Oil Rubbed Bronze
- Polished Brass
- Satin Black Chrome
- Satin Brass
- Satin Chrome Plate
- Satin Nickel

Technical specifications	Functions	Warranty	Accessories
<b>Backset</b> - 23mm standard - 30mm and 38mm also available  <b>Door thickness</b> - 32mm - 48mm standard - 51mm - 76mm also available  <b>Door type</b> - Metal - Timber	- C - Combination - V - Vestibule	30 year mechanical	- Extended spindles - Metal or wood face plate - Long and short lipped strikes (V)  <b>Furniture</b> - Legge 5300/5400 Series

## Legge 951 short backset locks



951 door lock  
28mm throw



950 door lock  
37mm throw



951 strike  
timber forend

- Satin Chrome Plate

Technical specifications	Functions	Warranty	Accessories
<b>Backset</b> - 23mm (narrow stile)  <b>Door thickness</b> - 32mm - 55mm  <b>Door type</b> - Metal - Timber	- 950 (swing) - 951 (sliding)	10 year mechanical	- Single cylinder and turn - Double cylinder - Slam shut strike plate

## Schlage SR keying



Standard Oval Cylinder



PD Cylinder



Rim Cylinder



Round Mortice Cylinder



Euro Cylinder

- Antique Bronze
- Chrome Plate
- Oil Rubbed Bronze
- Polished Brass Unlacquered
- Satin Black Chrome
- Satin Brass Unlacquered
- Satin Chrome Plate
- Satin Nickel

Technical specifications	Materials	Warranty
<ul style="list-style-type: none"> <li>- Drill resistant</li> <li>- Keys cut to depths 0 to 10</li> <li>- Housing standard shape and size</li> </ul>	<ul style="list-style-type: none"> <li>- Nickel silver keys</li> </ul>	<ul style="list-style-type: none"> <li>10 year mechanical</li> </ul>







Door controls

Briton door closers



1120



1120T



1130



1130T

● Black

● Satin Stainless Steel

● Silver



Fire rated

Technical specifications	Models	Warranty	Accessories
<ul style="list-style-type: none"> <li>- Universal application fits standard, top jamb, and parallel arm installations</li> <li>- Independent adjustable valves for backcheck, closing, and latching speeds</li> <li>- Non-handed</li> </ul> <p><b>Functions</b></p> <ul style="list-style-type: none"> <li>- Regular (R)</li> <li>- Hold open (HO)</li> </ul>	<p><b>1120</b></p> <ul style="list-style-type: none"> <li>- Regular arm</li> <li>- 850mm-1100mm maximum door width</li> <li>- 45-80kg door weight</li> <li>- 2-4 adjustable closer strength</li> </ul> <p><b>1120T</b></p> <ul style="list-style-type: none"> <li>- Track arm</li> <li>- 850mm-1100mm door width for parallel arm</li> <li>- 750mm-950mm for track arm</li> <li>- 40-80kg weight for parallel arm</li> <li>- 20-60kg for track arm</li> <li>- 1-3 adjustable closer strength</li> </ul> <p><b>1130</b></p> <ul style="list-style-type: none"> <li>- Regular arm</li> <li>- 850mm-1400mm maximum door width</li> <li>- 40-120kg door weight</li> <li>- 2-6 adjustable closer strength</li> </ul> <p><b>1130T</b></p> <ul style="list-style-type: none"> <li>- Track arm</li> <li>- 850mm-1250mm door width for parallel arm</li> <li>- 850mm-1100mm for track arm</li> <li>- 40-100kg weight for parallel arm</li> <li>- 40-80kg for track arm</li> <li>- 1-4 adjustable closer strength</li> </ul>	<p>10 year mechanical</p>	<ul style="list-style-type: none"> <li>- Hold open arm</li> <li>- Track arm</li> <li>- Parallel arm bracket</li> <li>- Adaptor plate</li> <li>- Parallel arm drop plate</li> </ul>

## Briton concealed cam action closer



2400 Series

● Black    ● Satin Stainless Steel    ● Silver

Technical specifications	Models	Functions	Warranty
<b>Door type</b> - Timber or metal <b>Angle of opening</b> - 80° - 80°-120° mechanical hold-open (optional)	<b>2400</b> - 850-1100mm size - 40-80kg weight - Non handed type - 2-4 adjustable strength - Track (2420T)	- Compact concealed overhead closer - Extruded aluminium body with cam action technology - High quality hydraulic fluid with built-in temperature compensation - Aluminium side track	10 year mechanical



## CAM action door closers

Selecting the correct door closer for your next project is an important part of satisfying end user needs and meeting necessary compliance requirements. Fire and Smoke Doors are one of those areas where adherence to the code should never be compromised and some consideration is needed when selecting the correct door control device.

Cam Action Door Control is widely accepted as being the go-to solution with its unique CAM driven mechanism providing a much smoother operation and favorable ease of use by producing exceptionally lower opening forces. The real beauty of this technology however is that the closing forces are maintained efficiently. Cam Action Door Control also provides a clean aesthetic which will compliment any door.

The Briton 2700 Cam Action Door Closer \*pictured\*, is a robust and feature packed unit which not only includes industry standard, independent 2 stage speed control and back check functionality, but also includes a delayed action function which is ideal for applications in Health Care and Aged Care environments. The Briton 2700 Cam Action Door Closer is designed to meet the requirements of AS1428.1 making it ideal for applications where DDA Access compliance is nominated.

## Briton surface cam action closers



2300 Series



2700 Series



Accessible



Fire rated



Black



Satin Stainless Steel



Silver

Technical specifications	Models	Functions	Warranty
<b>Door type</b> - Timber or metal <b>Angle of opening</b> - 80° - 80°-120° mechanical hold-open (optional)	<b>2300</b> - Pull side (2320) - Push side (2321BT) - 850mm-1100mm size - 40-80kg weight - 2-4 adjustable strength <b>2700</b> - 850mm-1250mm size - 40-100kg weight - Push/pull type - 1-5 adjustable strength	- Extruded aluminium body with cam action technology - High quality hydraulic fluid with built-in temperature compensation - Backcheck	10 year mechanical

## LCN Door Closers



4040SE door closer

● Aluminium

Technical specifications	Models	Warranty	Accessories
<ul style="list-style-type: none"> <li>- Interfaces with fire alarm systems</li> <li>- Independent adjustment valves for adjusting backcheck, closing and latching speeds.</li> <li>- Closer cylinder constructed of high strength cast iron for increased durability.</li> </ul>	<ul style="list-style-type: none"> <li>- Internal 711mm - 1219mm</li> <li>- Universal, fully reversible, nonhanded door closer</li> <li>- Hold open when powered</li> <li>- Regular when off</li> </ul> <p><b>4314ME*</b></p> <ul style="list-style-type: none"> <li>- Internal 660mm - 1220mm</li> <li>- Provides infinitely adjustable hold open points for fire and smoke barrier doors</li> <li>- Regular or swing-free</li> <li>- Adjustable hold open</li> </ul>	<ul style="list-style-type: none"> <li>- 30 year mechanical</li> <li>- 2 year electronic</li> </ul>	<ul style="list-style-type: none"> <li>- Track arm</li> <li>- Single non-handed track</li> <li>- Track slider</li> <li>- Adaptor plate</li> </ul>

## LCN 4031 & 4031T Series



4031 Series door closer  
(Hold open arm shown)



4031T Series door closer

● Aluminium

 Accessible
  Fire rated

Technical specifications	Models	Warranty	Accessories
<ul style="list-style-type: none"> <li>- Universal, fully reversible, non handed door closer</li> <li>- Independent adjustable valves for backcheck, closing, and latching speeds</li> <li>- Optional SRI primer for corrosive conditions</li> <li>- High strength cast iron construction</li> </ul> <p><b>Door type</b></p> <ul style="list-style-type: none"> <li>- Timber or metal</li> </ul> <p><b>Functions</b></p> <ul style="list-style-type: none"> <li>- Regular (R)</li> <li>- Hold open (HO), optional</li> </ul>	<p><b>4031</b></p> <ul style="list-style-type: none"> <li>- Regular arm</li> <li>- Internal door size 660mm-1219mm</li> <li>- External door size 660mm-914mm</li> <li>- 1-4 adjustable closer strength</li> </ul> <p><b>4031T</b></p> <ul style="list-style-type: none"> <li>- Track arm</li> <li>- Internal door size 660mm-965mm</li> <li>- 1-3 adjustable closer strength</li> </ul>	30 year mechanical	<ul style="list-style-type: none"> <li>- Non handed metal cover</li> <li>- Non handed single lever arm</li> <li>- Drop plate</li> <li>- PA shoe</li> <li>- Hold open arm</li> <li>- Adaptor plate</li> </ul> <p><b>4031T only</b></p> <ul style="list-style-type: none"> <li>- Standard track</li> <li>- Hold open clip</li> </ul>

## LCN 1461 & 1461T Series



1461 Series door closer



1461T Series door closer

● Aluminium

 Accessible
  Fire rated

Technical specifications	Models	Warranty	Accessories
<ul style="list-style-type: none"> <li>- Universal, fully reversible, non handed door closer</li> <li>- Certified NSI/BHMA A 156.4-2019 American Standard for door controls-closers</li> <li>- Tested to 2,000,000 cycles</li> <li>- High-strength cast iron construction</li> </ul> <p><b>Door type</b></p> <ul style="list-style-type: none"> <li>- Interior, exterior</li> <li>- Timber or metal</li> </ul> <p><b>Functions</b></p> <ul style="list-style-type: none"> <li>- Regular (R)</li> <li>- Hold open (HO)</li> <li>- Delayed action (DA)</li> <li>- Cush-n-stop (CNS)</li> <li>- Hold open cushion-stop (CNS-HO)</li> </ul>	<p><b>1461</b></p> <ul style="list-style-type: none"> <li>- Regular arm</li> <li>- Internal door size 610mm-1524mm</li> <li>- External door size 610mm-1219mm</li> <li>- 1-6 adjustable closer strength</li> </ul> <p><b>1461T</b></p> <ul style="list-style-type: none"> <li>- Track arm</li> <li>- Internal door size 660mm-965mm</li> <li>- 1-3 adjustable closer strength</li> </ul>	30 year mechanical	<ul style="list-style-type: none"> <li>- Non handed metal cover</li> <li>- Hold open clip</li> <li>- Adaptor plate</li> <li>- Drop plate</li> <li>- PA shoe</li> </ul> <p><b>1461 only</b></p> <ul style="list-style-type: none"> <li>- Blade stop spacer</li> </ul> <p><b>1461T only</b></p> <ul style="list-style-type: none"> <li>- Track roller</li> <li>- Track bumper</li> </ul>

## LCN 4040XP & 4040XPT Series



4040XP Series door closer  
(Hold open arm shown)



4040XPT Series door closer

● Aluminium



Accessible



Fire rated

Technical specifications	Models	Warranty	Accessories
<ul style="list-style-type: none"> <li>- Universal, fully reversible, non handed door closers</li> <li>- Independent adjustable valves for backcheck, closing and latching speeds</li> <li>- High strength cast iron construction</li> </ul> <p><b>Door type</b></p> <ul style="list-style-type: none"> <li>- Timber or metal</li> </ul> <p><b>Functions</b></p> <ul style="list-style-type: none"> <li>- Regular (R)</li> <li>- Hold open (HO)</li> <li>- Cush-n-stop (CNS)</li> <li>- Hold open cust-n-stop (CND-HO)</li> </ul>	<p><b>4040XP</b></p> <ul style="list-style-type: none"> <li>- Internal 610mm-1524mm</li> <li>- External 610mm-1219mm</li> <li>- 1-6 adjustable closer strength</li> </ul> <p><b>4040XPT</b></p> <ul style="list-style-type: none"> <li>- Internal 610mm-1219mm</li> <li>- External 762mm-914mm</li> <li>- 1-4 adjustable closer strength</li> </ul>	<p>30 year mechanical</p>	<ul style="list-style-type: none"> <li>- Adaptor plate</li> <li>- Drop plate</li> <li>- Hold open arm</li> <li>- Cush-n-stop arm</li> <li>- Hold open cush-n-stop arm</li> <li>- Metal cover</li> </ul> <p><b>4040XPT only</b></p> <ul style="list-style-type: none"> <li>- Track roller</li> <li>- Hold open clip</li> </ul>

Note: LCN4041 delayed action model also available  
Please speak to your Allegion consultant for more information



## Briton floor springs



5000 Floor spring



7500 Floor spring

● Satin Stainless Steel

Technical specifications	Models	Warranty	Accessories
<ul style="list-style-type: none"> <li>- Tested to 500,000 cycles</li> <li>- Dual action floor spring with 3 installation adjustments</li> <li>- Closing and latching speed adjustments control the door during operation</li> <li>- Cast iron body</li> </ul> <p><b>Functions</b></p> <ul style="list-style-type: none"> <li>- Non hold open</li> <li>- Hold open 90°</li> <li>- Hold open 105°</li> </ul>	<p><b>5000</b></p> <ul style="list-style-type: none"> <li>- 307mm (L) x 108mm (W) x 40mm (D)</li> <li>- 100kg door weight</li> <li>- 44mm minimum timber door thickness</li> <li>- 37mm minimum metal door thickness</li> <li>- 10mm-12mm glass door thickness with patch fittings</li> <li>- 1000mm maximum door leaf width (5003)</li> <li>- 1100mm maximum door leaf width (5004)</li> <li>- 3 fixed closer strength (5003)</li> <li>- 4 fixed closer strength (5004)</li> </ul> <p><b>7500</b></p> <ul style="list-style-type: none"> <li>- 341mm (L) x 78mm (W) x 60mm (D)</li> <li>- 300kg door weight</li> <li>- 40mm minimum timber door thickness</li> <li>- 37mm minimum metal door thickness</li> <li>- 750mm-1400mm maximum door leaf width</li> <li>- 3-6 adjustable closer strength</li> </ul>	<p>10 year mechanical</p>	<ul style="list-style-type: none"> <li>- Cover plate</li> <li>- Top pivot</li> <li>- Bottom strap</li> <li>- Offset pivot</li> <li>- Interchangeable spindle 5mm-35mm</li> </ul>

## Briton 2800 concealed transom closers



● Aluminium

Technical specifications	Functions	Warranty	Accessories
<ul style="list-style-type: none"> <li>- Adjustable spring strength to suit door size</li> <li>- Adjustable closing and latch speed</li> <li>- Optional 90° and 105° hold open</li> <li>- Side load arm standard, optional end load arm</li> <li>- Max door weight 80kg</li> </ul> <p><b>Door type</b></p> <ul style="list-style-type: none"> <li>- Timber or metal doors</li> </ul> <p><b>Closer strength</b></p> <ul style="list-style-type: none"> <li>- 2-4 adjustable</li> </ul> <p><b>Door size</b></p> <ul style="list-style-type: none"> <li>- 1100mm maximum width</li> </ul>	<ul style="list-style-type: none"> <li>- Non hold open</li> <li>- Hold open 90°</li> <li>- Hold open 105°</li> </ul>	<p>10 year mechanical</p>	<ul style="list-style-type: none"> <li>- Cover plate</li> <li>- Bottom pivot</li> <li>- End load arm</li> <li>- Heavy duty pivot</li> <li>- Metal fire box</li> </ul>

## Briton pivot sets



2800



7500

● Satin Stainless Steel

Technical specifications	Model	Warranty
<ul style="list-style-type: none"> <li>- Adjustable top pivot set</li> <li>- Stainless steel cover plate for top pivot</li> <li>- Needle roller bearing for top pivot</li> <li>- Height adjustable bottom strap</li> </ul> <p><b>Door type</b></p> <ul style="list-style-type: none"> <li>- Timber or metal</li> </ul> <p><b>Accessories</b></p> <ul style="list-style-type: none"> <li>- Fixings for timber and steel</li> </ul>	<p><b>2800</b></p> <ul style="list-style-type: none"> <li>- Up to 1100mm door size</li> <li>- 40mm door thickness</li> <li>- 80kg maximum door weight</li> </ul> <p><b>7500</b></p> <ul style="list-style-type: none"> <li>- Up to 1400mm door size</li> <li>- 250kg maximum door weight</li> </ul>	10 year mechanical

## Ives flush bolts



Ives FB41T  
(Top)



Ives FB41B  
(Bottom)

● Satin Chrome Plate

Technical specifications	Door type	Material	Warranty
<ul style="list-style-type: none"> <li>- Bolt: 19mm throw with 22mm vertical adjustment</li> <li>- Body size: 216mm (L) x 25mm (W) x 52mm (D)</li> </ul>	Timber	<ul style="list-style-type: none"> <li>- Steel plate</li> <li>- Cast brass</li> </ul>	10 year mechanical

## Ives door coordinators



COR32



COR7G



Fire rated

- Aluminium
  Satin Chrome Plate

Technical specifications	Door type	Material	Warranty
- COR32 - 864mm-1320mm door opening - COR42 - 1320mm-1830mm door opening - COR52 - 1575mm-2340mm door opening	- Timber - Metal	Aluminium	10 year mechanical
- COR7G and COR9G - up to 101mm (active door) and 1016mm (with astragal on inactive door), or up to 864mm (astragal on both doors)		Forged brass	

## Briton door selectors



- Satin Stainless Steel

Technical specifications	Door type	Material	Warranty
- B3000/180 for pairs of doors up to 1800mm - B3000/230 for pairs of doors up to 2400mm - B4000/305 for doors fitted with exit hardware	- Timber - Metal	Stainless steel	10 year mechanical





Exit devices

## Briton 370 Series



B376E Vertical panic bolt



B378E Reversible rim panic latch

 Fire rated



B379E Exit Device

● Silver

Technical specifications	Model	Warranty
<ul style="list-style-type: none"> <li>- Single door applications</li> <li>- Tested to 600,000 cycles</li> <li>- Reversible</li> </ul> <p><b>Door type</b></p> <ul style="list-style-type: none"> <li>- Timber or metal</li> </ul> <p><b>Door size</b></p> <ul style="list-style-type: none"> <li>- 665mm - 1300mm (W)</li> </ul> <p><b>Stile width</b></p> <ul style="list-style-type: none"> <li>- Minimum 78mm with 13mm rebates</li> <li>- Minimum 90mm with 25mm rebates</li> </ul>	<ul style="list-style-type: none"> <li>- Zinc die cast chassis</li> <li>- Steel rods and crossbars</li> </ul>	<p>10 year mechanical</p>

# Von Duprin 22 Series



Rim device  
(VD22EO)



Vertical rod device  
(VD2227EO)

● Aluminium

(Special finishes on request)



Fire rated

Technical specifications	Warranty	Accessories
<ul style="list-style-type: none"> <li>- Single and double door applications</li> <li>- Reversible handing</li> <li>- Surface mounting</li> <li>- Available in two lengths: 914mm and 1220mm</li> </ul> <p><b>Door type</b></p> <ul style="list-style-type: none"> <li>- Aluminium</li> <li>- Timber</li> <li>- Metal</li> </ul> <p><b>Door thickness</b></p> <ul style="list-style-type: none"> <li>- Surface mounted: 19mm minimum</li> <li>- Through bolt: 44mm to 57mm</li> </ul> <p><b>Door width</b></p> <ul style="list-style-type: none"> <li>- 914mm-673mm minimum*</li> <li>- Up to 2314mm for vertical rod device (3050mm high when fitted with extension rods)</li> </ul> <p><b>Stile width</b></p> <ul style="list-style-type: none"> <li>- VD22 minimum 111mm with optional 1609 strike</li> <li>- VD2227 minimum 92mm</li> </ul>	<p>10 year mechanical</p>	<ul style="list-style-type: none"> <li>- Alarm kit</li> <li>- Knob</li> <li>- Lever</li> <li>- Nightlatch</li> <li>- Thumbpiece</li> <li>- Vertical extension rods</li> <li>- Hex dogging key</li> </ul>

\*Based on standard strike and 13mm stop

## Von Duprin 33A Series



VD33EO

● Satin Chrome Plate



Technical specifications	Warranty	Accessories
<ul style="list-style-type: none"> <li>- Single and double door applications</li> <li>- Non-handed</li> <li>- Push pad exit device</li> <li>- VD3327A-EO – exit only surface mounted vertical rod device (suitable for standard door height 2134mm)</li> </ul> <p><b>Door type</b></p> <ul style="list-style-type: none"> <li>- Timber</li> <li>- Metal</li> </ul> <p><b>Door thickness</b></p> <ul style="list-style-type: none"> <li>- Surface mounted: 19mm minimum</li> <li>- Through bolt: 44mm–57mm</li> </ul> <p><b>Door width</b></p> <ul style="list-style-type: none"> <li>- 711mm–914mm</li> </ul> <p><b>Stile width</b></p> <ul style="list-style-type: none"> <li>- Double rebated door: 76mm minimum with optional 1609 strike</li> <li>- Double non-rebated door: 44mm minimum</li> </ul>	<p>10 year mechanical</p>	<ul style="list-style-type: none"> <li>- Exit alarm kit</li> <li>- Electric latch retraction</li> <li>- Nightlatch</li> <li>- Lever</li> <li>- Vertical extension rods</li> <li>- Hex dogging key</li> <li>- Universal strikes</li> </ul>

## Von Duprin 88 Series



VD88EO

● Satin Chrome Plate



Technical specifications	Warranty	Accessories
<ul style="list-style-type: none"> <li>- Single and double door applications</li> <li>- Reversible handing</li> <li>- Push bar exit device</li> </ul> <p><b>Door type</b></p> <ul style="list-style-type: none"> <li>- All door types</li> </ul> <p><b>Door thickness</b></p> <ul style="list-style-type: none"> <li>- Surface mounted: 19mm minimum</li> <li>- Through bolt: 44mm–57mm</li> </ul> <p><b>Door width</b></p> <ul style="list-style-type: none"> <li>- 600mm minimum</li> </ul> <p><b>Stile width</b></p> <ul style="list-style-type: none"> <li>- VD88EO: 111mm minimum with standard 299 strike; 100mm minimum with optional 1606 strike</li> <li>- VD8827EO: 71mm minimum on single door; 64mm min on double non-rebated doorset</li> </ul>	<p>10 year mechanical</p>	<ul style="list-style-type: none"> <li>- Vertical extension rods</li> <li>- Hex dogging key</li> <li>- Universal strikes</li> <li>- Vertical extension rods</li> </ul>



## Von Duprin 99 Series



VD99EO

● Satin Chrome Plate

Technical specifications	Models	Warranty	Accessories
<ul style="list-style-type: none"> <li>- Single and double door applications</li> <li>- Reversible handing</li> <li>- Push pad exit device</li> </ul> <p><b>Door type</b></p> <ul style="list-style-type: none"> <li>- Aluminium, hollow metal or timber hinged doors</li> </ul> <p><b>Door thickness</b></p> <ul style="list-style-type: none"> <li>- Surface mounted: 19mm minimum</li> <li>- Through bolt: 44mm-57mm</li> </ul> <p><b>Door width</b></p> <ul style="list-style-type: none"> <li>- 711mm minimum*</li> </ul> <p><b>Stile width</b></p> <ul style="list-style-type: none"> <li>- VD99EO: 111mm minimum with standard 299 strike</li> <li>- VD9927EO: 94mm minimum</li> </ul>	<ul style="list-style-type: none"> <li>- VD99EO: exit only rim device</li> <li>- VD99EO-F: exit only fire rated rim device</li> <li>- VD9927EO: exit only surface mounted vertical rod device</li> <li>- VD9927EO-F: exit only fire rated surface mounted vertical rod device (suitable for standard door height 2134mm)</li> </ul>	<p>10 year mechanical</p>	<ul style="list-style-type: none"> <li>- Exit alarm kit</li> <li>- Quiet electric latch retraction</li> <li>- Nightlatch with pull</li> <li>- Breakaway lever</li> <li>- Vertical extension rods</li> <li>- Hex dogging key</li> <li>- Universal strikes</li> </ul>

\*Based on standard strike and 13mm stop height

## Von Duprin Exit Device



CHEXIT™ Controlled Exit Device

CX Chexit is designed for use on delayed exit applications. CX98 and CX99 are available for rim, mortice lock and surface and concealed vertical rod mounting styles. The Chexit system will keep an exit door secured for a 15 second period, yet tied into the fire alarm system will release immediately when an alarm condition exists.

Technical specifications	Functions	Warranty
<ul style="list-style-type: none"> <li>- Continuous duty: 24VDC</li> <li>- Current in-rush: 16 amperes</li> <li>- Current Holding: 3 amperes</li> <li>- Set-up for normally closed dry contacts</li> </ul>	<ul style="list-style-type: none"> <li>- Non handed</li> <li>- Field sizable</li> <li>- Remote alarm</li> <li>- Key switch</li> <li>- Indicator lamp</li> </ul>	<ul style="list-style-type: none"> <li>- 10 year mechanical</li> <li>- 1 year electronic</li> </ul>





Sliding Top  
Hung Hardware

## Brio Zero Clearance



Sets comprise track, brackets, two hangers, door clips, guide, all screws and installation instructions.

Product	Max. Panel weight	Max. Panel height	Min. Panel thickness
Zero Clearance 180	180kg	3000mm	40mm
Zero Clearance 350	350kg	3000mm	40mm

## Brio Quick Run 120



Sets comprise of track, two hangers, two hanger stops or soft close, one guide, fixings and installation instructions for 1 panel.

Product	Max. Panel weight	Max. Panel height	Min. Panel thickness
Quick Run 120 Zero Clearance	120kg	3000mm	32mm - 45mm
Quick Run 120 Surface Mount	120kg	3000mm	28mm - 45mm
Quick Run 120 recessed/aluminium	120kg	3000mm	32mm - 45mm

## Brio Open Rail

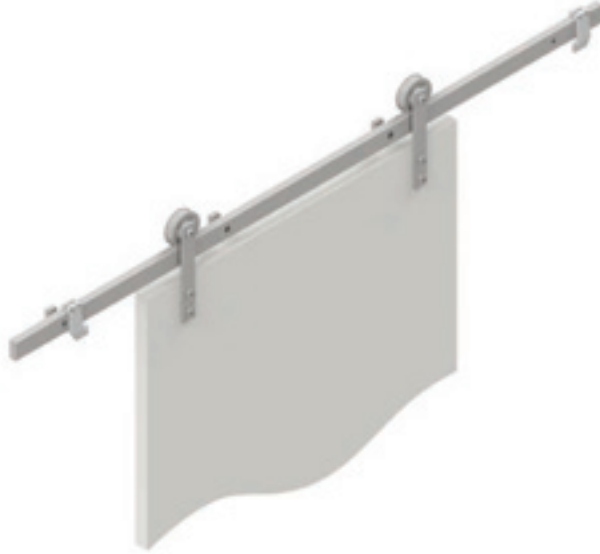

Packs comprise 2 hangers, door stops, guide, handle, brackets and fixings.

Product	Max. Panel weight	Max. Panel height	Min. Panel thickness
Open Bar Rail Timber 80	80kg	1250mm	35mm - 44mm
Open Bar Rail Timber 100	100kg	2000mm	35mm - 44mm
Open Bar Rail Glass 100	100kg	2000mm	8mm - 12mm
Open Square Rail Timber 100	150kg	2000mm	35mm - 44mm

## Gainsborough Sliding Cavity Set



395 Circular Privacy  
Sliding Cavity Set



396 Circular Passage  
Sliding Cavity Set

● Brushed Satin Chrome ● Chrome Plate ● Matte Black ● Aged Brushed Copper

Technical specifications	Models	Warranty	Accessories
<ul style="list-style-type: none"> <li>- Internal application</li> <li>- Backset (mm): 60</li> <li>- Bore Hole (mm): 54</li> <li>- Edge Bore (mm): 25 (395 only)</li> </ul>	<p><b>395</b></p> <ul style="list-style-type: none"> <li>- Locking</li> <li>- Latch included</li> <li>- Privacy function with an external emergency release, best suited to bathroom and ensuite sliding doors</li> </ul> <p><b>396</b></p> <ul style="list-style-type: none"> <li>- Non-locking</li> <li>- Latch not included</li> <li>- Passage function for nonlocking general internal passage doors</li> </ul>	<ul style="list-style-type: none"> <li>- 10 year mechanical</li> <li>- 10 year tarnish</li> </ul>	<ul style="list-style-type: none"> <li>- Sliding cavity set with stylish circular escutcheon</li> <li>- With a 54mm diameter hole for easy installation and a 60mm backset</li> <li>- Lock or unlock with turn-button from inside</li> </ul>

## Gainsborough Flush Pulls



Rectangular  
Flush Pull 150  
(730FP150)



Rectangular  
Flush Pull 250  
(730FP250)



Rectangular  
Flush Pull 350  
(730FP350)

● Antique Bronze ● Matte Black ● Satin Stainless Steel ● Satin Graphite ● Satin Brass

Technical specifications	Models	Warranty	Accessories
<ul style="list-style-type: none"> <li>- Internal application</li> <li>- Non-locking</li> <li>- Stainless steel material</li> </ul>	<p><b>730FP150</b> 150mmH x 50mmW x 14mmD</p> <p><b>730FP250</b> 250mmH x 50mmW x 14mmD</p> <p><b>730FP350</b> 350mmH x 50mmW x 14mmD</p>	<ul style="list-style-type: none"> <li>- 15 year mechanical</li> <li>- 5 year tarnish</li> </ul>	<ul style="list-style-type: none"> <li>- Contemporary rectangular design is simple, modern and elegant</li> <li>- Conealed fixings for a simple and clean look</li> </ul>







General  
hardware

## Door stops



6202



L12801



L12802



12841



6205



13001



6207

Models	Fixing	Finishes	Size
6202	Floor	- Satin Chrome Plate - Matte Black	45mm diameter, 75mm projection
L1208	Floor	Satin Pearl	50mm diameter, 38mm projection
L12802	Floor	Satin Stainless Steel	45mm diameter, 60mm projection
L12802	Floor	Matte Black	45mm diameter
12841	Door	- Chrome Plate - Satin Chrome Plate	28mm diameter, 85mm projection
6205	Floor	- Satin Chrome Plate - Matte Black - Bright Chrome - Satin Brass - Satin Graphite	45mm diameter
13001	Wall	Satin Pearl	45mm diameter, 80mm projection
6207	Wall	- Satin Chrome Plate - Matte Black - Bright Chrome - Satin Brass - Satin Graphite	50mm diameter, 75mm projection

## Legge pull handles and push plates



100 Series



200 Series



300 Series



300 Series



1351



1353

● Polished Stainless Steel (on special request)

Models	Description	Dimensions	Fixing	Warranty
100 Series	Push/Pull plate	300mm x 65mm plate 15 = 150mm x 16mm pull 16 = 150mm x 16mm pull	Visible/Concealed	10 year mechanical
200 Series	Push/Pull plate	300mm x 65mm plate 15 = 150mm x 16mm pull 16 = 200mm x 16mm pull	Visible/Concealed	10 year mechanical
300 Series	Push plate	300mm x 100mm 200mm x 16mm pull	Visible/Concealed	10 year mechanical
1351	Pull handle (also available without rose)	150mm x 16mm pull 200mm x 16mm pull with rose	Visible	10 year mechanical
1353	Offset pull handle on 38mm rose	200mm x 16mm	Visible	10 year mechanical

## Legge architectural hinges



13221



13222

- Matte Black
- Satin Stainless Steel
- Polished Stainless Steel



13225

- Matte Black
- Satin Stainless Steel

Models	Description	Dimensions
13221-01	Broad butt, loose pin hinge	100mm x 75mm
13221-03	Broad butt, loose pin hinge	100mm x 100mm
13222-02	Broad butt ball bearing hinge, fixed pin	100mm x 75mm
13222-04	Broad butt ball bearing hinge, fixed pin	100mm x 100mm
13225	Fast fix ball bearing hinge, fixed pin	100mm x 68mm

## Schlage door viewer



SDC18500

- Matte Black
- Satin Brass
- Satin Chrome Plate



Fire rated

Technical specifications	Warranty
<ul style="list-style-type: none"> <li>- 180 degree view angle</li> <li>- Brass material</li> </ul>	10 year mechanical

## Legge bolts - barrel and chain



L1731



L1751



1851



L1901

Chrome Plate
  Satin Chrome Plate
  Polished Brass

Models	Description	Size	Warranty
L1731-01	Necked Barrel Bolt	100mm	10 year mechanical
L1731-02	Necked Barrel Bolt	150mm	10 year mechanical
L1751-01	Barrel Bolt	100mm	10 year mechanical
L1751-02	Barrel Bolt	150mm	10 year mechanical
L1751-03	Barrel Bolt	200mm	10 year mechanical
L1751-04	Barrel Bolt	300mm	10 year mechanical
L1901-01	Flush Bolt	150mm	10 year mechanical
L1901-02	Flush Bolt	200mm	10 year mechanical
L1901-03	Flush Bolt	300mm	10 year mechanical
L1901-04	Flush Bolt	450mm	10 year mechanical
L1901-05	Flush Bolt	600mm	10 year mechanical

## Legge Floor Ferrules



L1760

Aluminum
  Polished Brass

Models	Product Suitability	Finishes
L1758	Suits 1731 & 1751	- Polished Brass - Satin Chrome
L1759	Suits 1731 & 1751	- Polished Brass - Aluminium
L1760	Suits 1901	- Polished Brass - Aluminium

## Schlage master keying

Most Schlage and Legge locks are supplied individually keyed. A well-designed keying system facilitates more control and increased security. Specially keyed systems have been developed to enable end users to assign access to individuals for locks they are authorised to operate. Lost ball construction keying is available.



### Keyed to Differ (KD)

All keys are individual and stand alone. Each lock can only be opened by its own individual key.

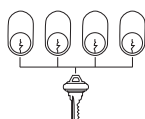

### Keyed Alike (KA)

The system allows a number of locks to be operated by the same key as they are keyed to a specific code. This system is particularly suitable for residential applications with front and back doors.

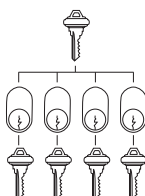

### Master keyed

This keying system locks in a group to be keyed individually and does not allow those individual keys to operate any other lock in the system. However all locks in the system can be operated by one master key.

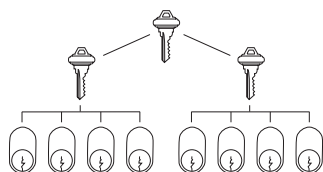

### Grand master key

With this system, locks in several groups are independently keyed with a master key for each group. Each group is independent of each other, and the grand master key will work with all locks in all groups.

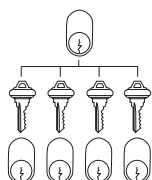

### Maison keying

A maison key system is a keying system that allows a lock to be opened with a number of unique individual keys. Typically found in applications like apartment buildings, it provides unrestricted access to common doors. Unlike master keyed systems, the lack of security makes this a less attractive option.

## Support at every step

With a portfolio of leading Australian and global brands, Allegion is able to assist you at every step of your project.

Our local team of experienced consultants and technical experts provide trusted advice to help successfully and proudly deliver projects with a focus on compliance, speed and operational efficiency.

From specification, to installation and maintenance, we can help

- Free hardware specifications through our industry leading platform, Overtur™
- Nationwide team of hardware consultants
- A dedicated Technical Support Hub to answer your technical queries
- Review of hardware submittals
- CPD-certified training
- Expert product training
- Compliance to building, life-safety and accessibility codes
- Job site reviews, and pre and post installation inspections
- Market leading warranties and after-sales support
- Keying schedules specific to each project's requirements



### Allegion's brands offer pioneering solutions

**Schlage** electronic access control

**Legge** commercial mechanical hardware

**Overtur™** specification collaboration platform

**Brio** sliding and folding hardware

**Briton** door controls

**Gainsborough** residential hardware

**LCN** door closers

**Von Duprin** exit devices

### When you partner with Allegion, you receive:

- **A dedicated resource**  
A highly experienced team of Consultants located around the country
- **Technical support hub**  
A team located in Australia to support you with your most complex technical queries or training support
- **Flexible solutions**  
Scalable solutions for any business need or budget
- **Compliant solutions**  
A range of products to meet Australian security, accessibility and fire standards.

Sales support **1800 098 094** or [info.au@allegion.com](mailto:info.au@allegion.com)

Technical support hub **1300 898 596** or [techsupport.au@allegion.com](mailto:techsupport.au@allegion.com)  
[allegion.com.au](http://allegion.com.au)

## About Allegion™

Allegion (NYSE: ALLE) is a global pioneer in seamless access, with leading brands like CISA®, Interflex®, LCN®, Schlage®, SimonsVoss® and Von Duprin®. Focusing on security around the door and adjacent areas, Allegion secures people and assets with a range of solutions for homes, businesses, schools and institutions.

For more, visit [www.allegion.com](http://www.allegion.com)

Brio ■ <FSH> ■ *Gainsborough* ■ LEGGE ■ SCHLAGE

Due to continuous product development, some products may vary from that shown. The Allegion guarantee, shown on the pages within, applies only when properly installed and subjected to no more than fair wear and tear. This guarantee does not extend to labour costs, personal loss, death or injury or economic, consequential or property damage of any kind whatsoever. Due to the nature of the printing process, colours may vary from those shown in this brochure.

### Allegion New Zealand

Freephone 0800 477 869  
Freefax 0800 477 868  
Email [nzinfo@allegion.com](mailto:nzinfo@allegion.com)  
[www.allegion.co.nz](http://www.allegion.co.nz)

### Allegion Australia

Freephone 1800 098 094  
Freefax 1800 098 095  
Email [info.au@allegion.com](mailto:info.au@allegion.com)  
[www.allegion.com.au](http://www.allegion.com.au)

999/AUCG\_COM  
© 2023 Allegion

